

D-BOX G5

Quick Start Guide

PACKAGE CONTENTS



> 1x Haptic Bridge



> 1x USB A to USB B Cable



> 1x USB-A Male to USB-A Female Extension Cable (3.0)



> 1x Power Supply



> Mounting Screws (4 per actuator)



> 1 to 4 Haptic Actuator(s)



> 1 to 5 IEC Plug-Lock Insert(s)



> Power Cables & "Y" Splitters

1250i	2x Power Cables
2250i	2x Power Cables + 1x "Y" Splitters
3250i	3x Power Cables + 1x "Y" Splitters
4250i	3x Power Cables + 2x "Y" Splitters

OPTIONS

(Choose from optional components)



> Endings (captive or non-captive)



> Brackets ("L" or "U" shape)



> Pivot Delrin

OVERVIEW

Thank you for purchasing your G5 haptic system! Please make sure to follow each step, one-by-one, to make your system operational.

- Unboxing
- Inventory
- Voltage Selection
- Haptic Actuator Endings
- Brackets Installation
- System Connection
- D-BOX Connect Account Creation
- D-BOX HaptiSync Center Installation
- System Configuration
- Test & Play

Complete G5 User Guide is available on our [website](#).

1 | UNBOXING

- 1 Unpack the product from the box.
- 2 Visually inspect the product for damage.
- 3 If any part appears to be broken, contact the D-BOX Support Team*.

2 | INVENTORY

Ensure that you have all the components necessary to assemble your system. Refer to the "Package Contents" section if needed.

3 | VOLTAGE SELECTION

Set all haptic actuators to meet your region power voltage by using the switch selector located underneath the casing:



4 | HAPTIC ACTUATOR ENDINGS

NON-CAPTIVE ENDINGS

G5 haptic actuators come native with non-captive endings. Once the actuators are installed on your platform, simply drop the actuators into the provided metal cups:



D-BOX G5

Quick Start Guide

4 | HAPTIC ACTUATOR ENDINGS (CONTINUED)

CAPTIVE ENDINGS (optional)

Please refer to the G5 User Guide for detailed instructions. **Never operate the haptic actuator(s) without the ending installed. This may lead to irreparable damages to the actuator.**



5 | BRACKETS INSTALLATION

Attach your haptic actuators to your platform using either the brackets provided by D-BOX or your reseller. "U" brackets should be mounted first on your platform.

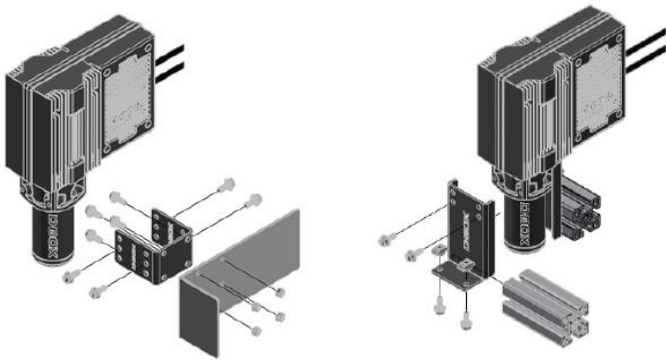

Reseller brackets could be attached in a different way depending on the model. Please refer to the reseller instructions.

6 | SYSTEM CONNECTION

1 Connect each actuator RJ45 cable to the Haptic Bridge port lettered as per the plan below. See [G5 User Guide](#) for detailed wiring diagrams.

HAPTIC BRIDGE

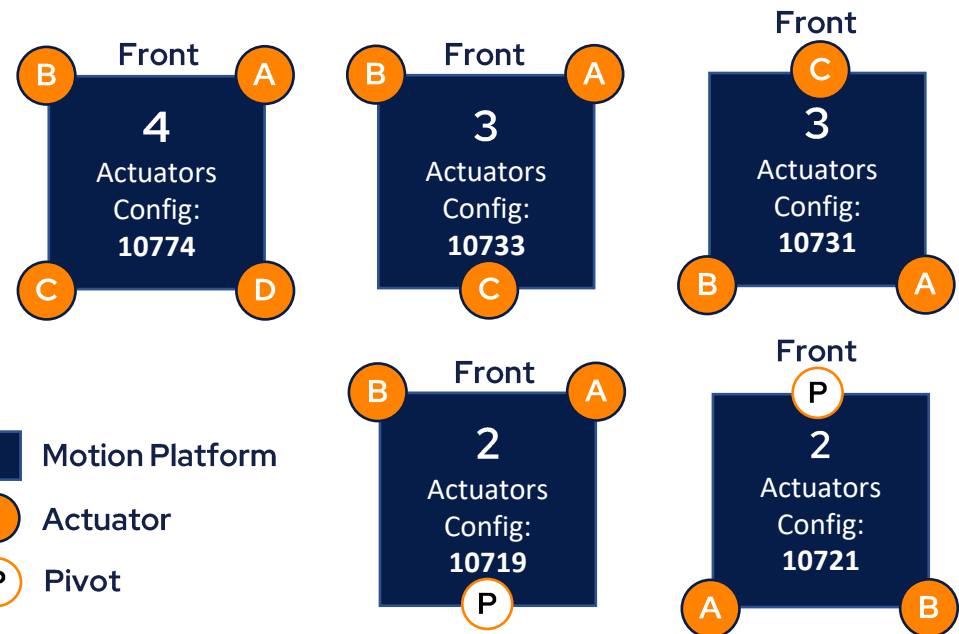
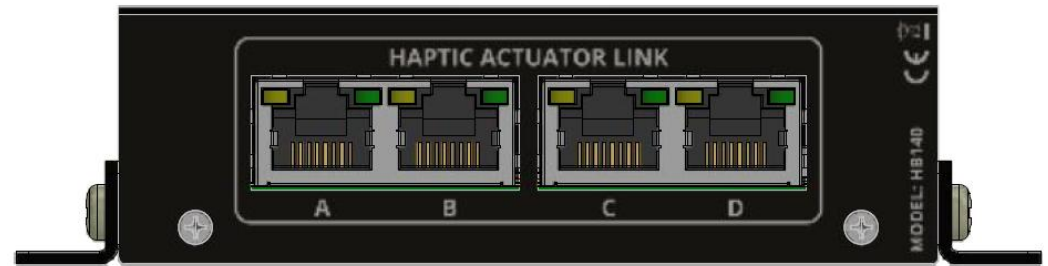

Configuration number to be entered in the D-BOX System Configurator (section 9)

D-BOX G5

Quick Start Guide

6 | SYSTEM CONNECTION (CONTINUED)

- 2 Connect the Haptic Bridge to your PC using the USB cable provided with your haptic system. Connect the power supply to the Haptic Bridge as well as to a power outlet.

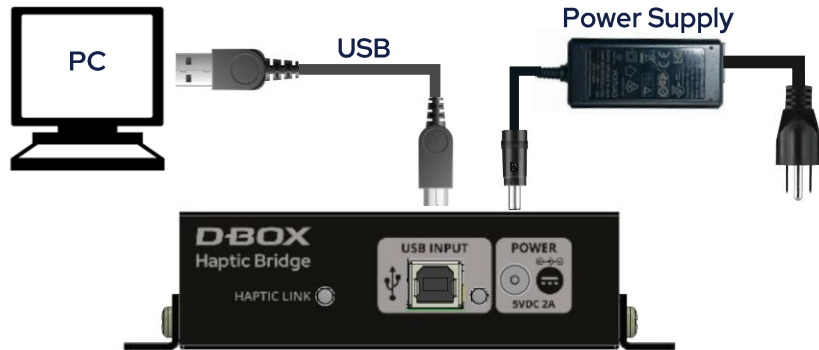

Do not connect your Haptic Bridge to a USB hub.

- 3 Connect all actuator power cables to a power outlet. Use the "Y" splitter(s) to simplify the connection.
Install an IEC Plug-Lock insert to each IEC female connector and make sure that all power cables are firmly inserted.



7 | D-BOX CONNECT ACCOUNT CREATION

Create your D-BOX account on the D-BOX Connect [website](#).

This is mandatory to install haptic codes for games (D-BOX Coded Gaming mode) and to have access to D-BOX Coded Video mode.

You will be prompted later to log in when opening D-BOX HaptiSync Center.

8 | D-BOX HAPTISYNC CENTER INSTALLATION

- 1 Download D-BOX HaptiSync Center from our [website](#).
- 2 Install the software on the computer (PC) that will be connected to your haptic system.

D-BOX HaptiSync software suite includes system's drivers in addition to the following software and utilities:

- D-BOX Adaptive Gaming Configurator
- D-BOX System Monitor Recorder
- D-BOX Stimuli Presenter

Take note that this software cannot be used until you complete your system configuration (section 9).

D-BOX G5

Quick Start Guide

9 | SYSTEM CONFIGURATION

Your Haptic Bridge comes with a blank configuration. You need to configure your Haptic Bridge to match your haptic system configuration using the D-BOX System Configurator.

1 Download D-BOX System Configurator from our [website](#).

2 Extract the compressed file and run the installer. Note that the User Guide is located in the Windows Start menu/D-BOX folder.

3 Firmware update:

a) Make sure your haptic system is powered on.

b) Open the D-BOX System Configurator from the Windows Start menu/D-BOX folder.

c) From the **Firmware Update** tab, click **Refresh Firmware Status**.

d) If the system shows “Outdated (Update firmware)”, click **Update Firmware** and follow the on-screen instructions.

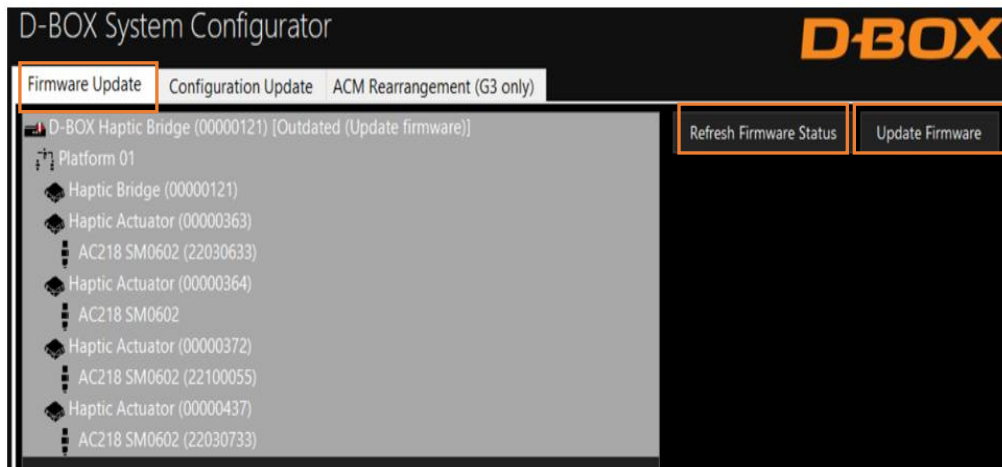

4 Configuration update:

a) Select the **Configuration Update** tab. Click **Refresh Information**.

Make sure the **Actuator Count** matches with your system. If not, make sure that all power cables and RJ45 are firmly connected.

b) Enter the configuration number matching your system (**see section 6**) or select the axes you want for your system. Click **Apply Configuration**.

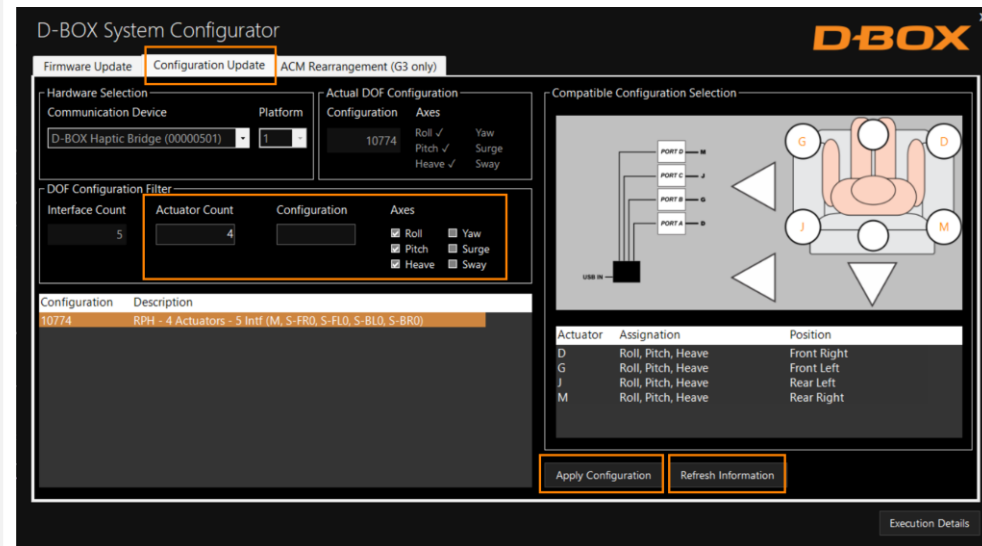

Close the System Configurator when completed.

D-BOX G5

Quick Start Guide

10 | TEST & PLAY

- 1 From the Windows Start menu, open D-BOX HaptiSync Center and enter your D-BOX Connect account credentials.
- 2 Make sure your HaptiSync Mode is set to **D-BOX Coded Gaming**.
- 3 Click on the **Haptic Output** tab, then click **Start Haptic System Test**.

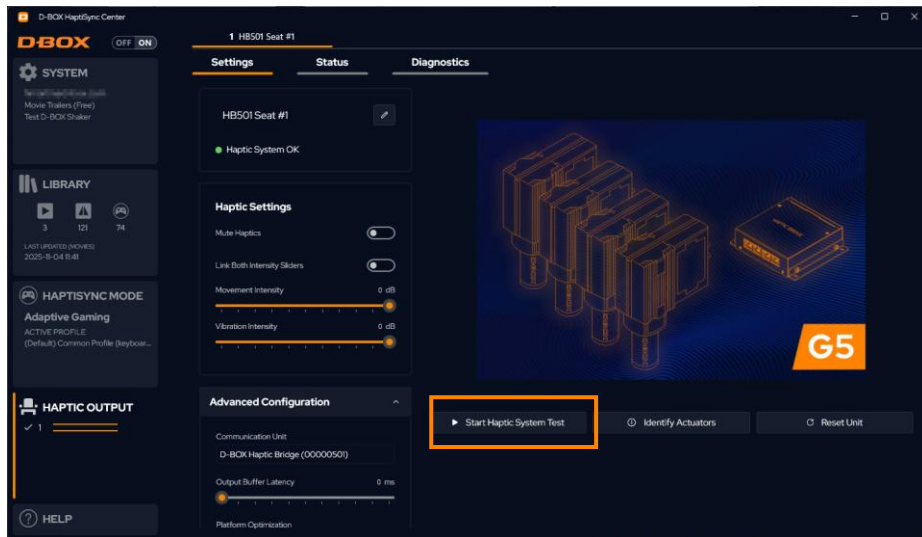

Your haptic system should start moving and vibrate following a factory haptic pattern.

- 4 Click **Stop Haptic System Test** to stop the test.

- 2 It's now time to enjoy your new haptic system with your favorite game or movie!

In the **HaptiSync Mode** tab, select the HaptiSync mode:

- **D-BOX Coded Gaming:** Premium haptic experiences for D-BOX coded apps, simulators & games. Use the **Adaptive Gaming** mode if your title is not in the list. Click [here](#) for more details.
- **D-BOX Coded Video:** Premium haptic experiences for D-BOX coded movies, TV shows, using audio synchronization. Click [here](#) for more details.
- **Adaptive Gaming:** Haptic experiences using real-time events from game controller or keyboard. Click [here](#) for detailed instructions on how to use this feature.
- **Adaptive Audio:** Automated haptic experiences for any movie, music, TV show and games using audio processing. Click [here](#) for more details.